

17 Fuse

A 'fuse' track is present on the controller: it is on the base board (beneath the 6 way connector of the top board) and is arrowed on the 'Features' diagram. It is provided to limit damage to the controller in the event of a fault in the external wiring. It is in the battery +ve line which feeds to pin D of the 4 way connector (ignition and meter) and to pin C of the 3 way connector (brake solenoid).

This fuse does not protect any of the controller's electronics, nor can it be blown by any fault in the controller. If it blows, the ignition will be off and the controller will be dead.

If this blows, first find and repair the cause of the fusing.

Two empty fuse clips are provided on the board where a standard 20mm fuse (1.0 amp) may be fitted if the track blows. These are between the two boards and the Features diagram has a section of the top board 'cut away' to show their position.

Controllers returned for repair with **only** this track blown will be subject to a charge for handling, test and carriage.

18 Fault finding

Most faults are caused by problems in the external wiring. The controller has many safeguards to restrict damage if there is a problem and an understanding of the safeguards should assist in finding faults.

All voltage measurements should be made with meter negative on the battery negative terminal.

The ignition switch applies battery voltage to pin 3 of the 4 way connector. This enables the controller's internal power supply. Until the internal supply is on the controller is dead. The internal supply (+12v) can be measured on pin 2 of the 6 way connector.

+12v is also applied (via pot fault detection circuitry) to the top of the throttle pot, pin 4, where you should measure around 11.4 volts.

As the throttle pot is moved it applies a variable voltage back to pin 5 of the 6 way connector. But there is a 'high pedal lockout' circuitry which prevents the controller taking off at high speed if the throttle is faulty: this resets itself when the voltage on pin 5 falls to zero.

So check that the throttle voltage varies from 0v upwards. The top voltage may be 11.4 or less (the gain can be adjusted to compensate) but never more than 11.4v. This does not apply to the uncommon Joystick mode where 'zero speed' is about 5.5v.

If the 12v is correct and the pot voltage is altering from zero upwards there is a fault in the controller.

Most faults in the controller will need attention at the factory as they require instruments and experience of such high current circuitry which are not usually available to electronic repair shops.

Dead or Loss of power

Most models include adjustable battery discharge protection which cuts back the power when the voltage in the controller drops too low.

If this is set too high for the battery voltage, it will inhibit operation.

Also - undervoltage protection cannot tell the difference between a flat battery and a poor connection or a bad wire. If the battery wires are too long and thin they will drop voltage - and this may result in a dramatic loss of power as the protection cuts in.

This feature may then require the use of thicker battery wire

Other faults

See our [www site!](http://www.4qd.co.uk) There is a large service section.

4 QD

Office Stores

30 Reach Road
Burwell
Cambridgeshire, CB5 0AH
Fax: 01638 744 080
<http://www.4qd.co.uk>

4 QD

Unit 6A
Heath Road Industrial Estate
Burwell
Cambridgeshire, CB5 0AP
Email to: support@4qd.co.uk

4 QD

"We're in Control"

See us via the Internet:

4 QD

Office Stores

30 Reach Road
Burwell
Cambridgeshire, CB5 0AH
Fax: 01638 744 080
<http://www.4qd.co.uk>

4 QD

"We're in Control"

Email to: support@4qd.co.uk

Instruction Manual

4QD series controllers

4QD-300-36 and 4QD-300-48

Issue 15 control board and issue 04 base board.

1 Foreword

We have tried to make this manual as readable as we can. We hope you will read it through before you start trying to install 4QD's motor controllers. Even if you don't understand everything to start with, reading it will make you familiar with what we are trying to say and do. We welcome feedback so if anything is unclear, please let us know.

This manual describes our standard range of controllers. Many options are available, so if there are points you want clarified, or features or specifications you want altered, please consult the factory.

In the section 'Features and Glossary' we have also discussed the controllers features, some of the controls you may wish to fit and the type of information you may need to make a choice of controller.

To help to avoid confusion, certain paragraphs are marked with a bullet ¶. These are more technical and may be omitted by the less technical reader.

2 Introduction

This manual covers the 4QD-300 series of heavy duty controllers (up to 300A) for 24v, 36v and 48v battery operated motors. The controllers are fully electronic giving control of the motor in all four 'quadrants' - that is forward and reverse, acceleration and braking - so they use no relays or mechanical switches, increasing reliability. All internal connections and wiring are rated to carry full current so the controller continuous ratings are only limited by external heat dissipation. Moreover the substantial built-in heatsink is designed so that additional heat sinking can be added in the unlikely event it is required.

The controllers use state-of-the-art MOSFET power transistors which are 'chopped' on and off very rapidly to give ultra-smooth speed control with minimum losses for best control with minimum heating in controller, motor and wiring.

During braking a large proportion of the braking energy is returned to the battery, helping to reduce battery drain and extend the time between charges.

Power connections are by substantial M8 screw terminals.

27th December 2004

3 Contents

- 1 Foreword
- 2 Introduction
- 3 Contents
- 4 Dos and Don'ts
- 5 Specifications
- 6 Features
- 7 Controls
- 8 Adjustments
 - Gain
 - Ramps
 - || Current
 - || Reverse Acceptance Threshold
 - || Reverse Speed
- 9 Wiring
 - Power connections
 - Battery & motor wire size
 - Battery wiring
 - || Reverse polarity protection
 - || Circuit breaker or fuse.
 - Motor wiring
 - Motor polarity
 - Using several motors
- 10
- 11 Control wiring
 - Pre-wired models
 - Connectors
 - 6 way connector
 - 4 way connector
 - 3 way connector
 - Wiring - various
 - Ignition switch
 - Battery meter
 - Ignition light
 - Speed control pot
 - Reverse switch
 - || Top Speed adjustment
 - || Brake solenoid
 - || Inhibit input
 - Hand control box
 - Output current & Heatsink
 - Mounting & Earthing
 - Waterproofing
 - Battery charging
 - Fuse
 - Fault finding
- 12
- 13
- 14
- 15
- 16
- 17
- 18

Additional Information

Although this manual is quite comprehensive, there is a limit to what it is sensible to print on paper. If you have queries, then you are best advised to consult our www site where there is a large amount of additional information including many instructions on some of the more arcane applications of this controller

4 Dos and Don'ts

Do

- Keep the controller covered at all times**- or water, dust and dirt will enter.
- Fit reverse polarity protection** - if there's any chance of someone connecting the battery wrongly
- Make sure terminal nuts are tight** - current through a loose connection will burn it.
- Keep the motor in good condition**. Damaged brushgear and commutators can blow the controller.
- Fit a motor suppression capacitor**. A 10n ceramic across the motor brushes, as close to the motor as possible, can greatly increase system reliability.

Do not

- Drill or otherwise modify the metal base** - it's impossible to keep metal swarf out of the controller. This WILL blow the controller!
- Test the controller without securing the top board in place**: as a bare minimum, loosely insert the two screws at the end away from the 6 way connector.
- Hard-wire the ignition**: this is also a reset switch if the controller trips for any reason!

15 Waterproofing

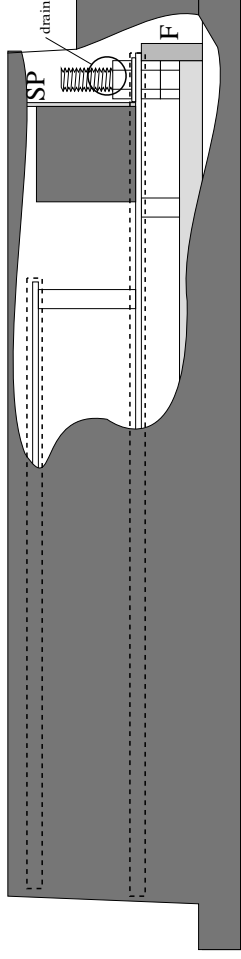

risk.

Most water problems are caused by condensation or by splashing. The 4QD controller's circuit boards are coated with a water resisting varnish so condensation is not a problem, especially as the controller will warm slightly in use, expelling any condensation. However water splashes must be kept away from the electronics and we at 4QD have taken great care to make sure this is done.

The vacuum formed cover of the controller is waterproof and will keep off water from above. The mouths of the controller (one each end) are sealed with a piece of waterproof foam between board and base (F in the above diagram of the 4QD-200)

Behind the terminals is a plastic splash plate (SP in diagram). A notch is present in this for control wires to pass through. For proper splash proofing this plate should be sealed to the board using Dow Corning 734 RTV - a free flowing silicone rubber with a consistency like treacle. Do not use ordinary si rubber - it won't do a good job and is very messy!

To use the silicone, remove the splash plate and wire the controller. Now, with the controller base plate horizontal and at the bottom, run a small bead of the silicone along the bottom (longest edge) of the splash plate before re-fitting it. The silicone will run down the plate and seal it to the board. Use the top cover to hold the splash plate in place. The silicone takes about 1/2 hour to partially set.

The controller is best mounted with the aluminium base horizontal at the bottom so water cannot run into the controller and collect inside the cover. Mounting with the base vertical is permitted but there is a slight risk of water being trapped by capillary action between the cover and one of the boards. If trapped in the wrong place this water could cause electrolytic corrosion and/or failure. A drainage hole near the mouth in the appropriate place would minimise this

Do not try to seal the base to the cover: this should be allowed to breathe so that any condensation or water which does enter can escape again.

In any machine you should consider whether it is likely to be exposed to water: where will the water come from, where will it go? Will water run along cables into the controller or into any connector or other sensitive point? If so you should make a small loop so the water drips off at the low point before it reaches the sensitive item.

If the controller is mounted on its side a drainage hole ('drain' on the diagram) in the mouth may allow water to run out. Also you can seal the splash plate to the side of the cover with the same silicone rubber. Several controllers have failed because water was allowed in and was held by capillary action between the boards and the cover in the area shown by a pecked outline. Water here may not cause immediate misbehaviour - until a track corrodes through!

16 Battery Charging

Unless a trip, circuit breaker or battery switch has been fitted, the 4QD-300 is permanently connected to the battery. The battery charger will not normally be capable of causing voltage spikes above the handling capacity of the MOSFETs in the controller which are rated at 50v (60v for -48 models). However if the batteries were ever removed whilst the charger is active some chargers could cause excessive voltage spikes so this possibility must be considered.

Hand Control Box

4QD controllers are used in many commercial electric vehicles and most of these use the same 6 pin plug and socket.

The pin wiring of this is shown in the diagram on the next page.

The diagram below shows an accessory hand control box type **HCB-622** which is available

Also shown is the control lead **CLB-635** which is used with **HCB-622**

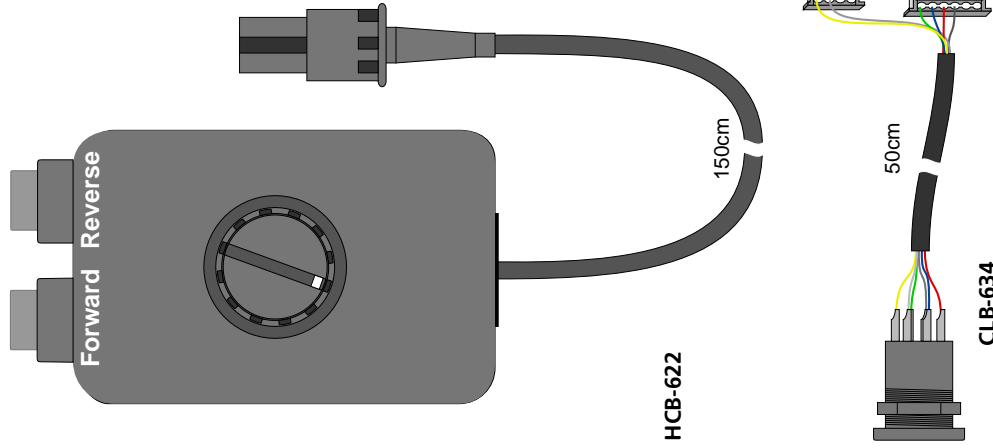

13 Output current and Heatsinking

The available output current depends on the temperature. A typical 4QD-300D controller, into a stalled motor, will give between 300 and 330 amps when cold, decreasing as the unit heats up until the overheat thermostat cuts in. In normal operation, full current will only be required intermittently in short bursts. However, the controller may warm up gradually and, if the usage is particularly arduous, the overheat thermostat will cut the controller off. The time taken to overheat is load and mounting dependant and is therefore not easily predicted, but the heatsink supplied is adequate for most requirements.

It is good practise if maximum lifetime is required, for electronic equipment not to be allowed to run too hot. Therefore, even if the overheat thermostat doesn't cut the controller off, if the heatsink runs hot to the touch then extra heatsinking may be required or a higher current controller is indicated.

14 Mounting and earthing

It is suggested that the electrical system not be earthed to chassis. 4QD-series controllers are isolated from the heatsink and the heatsink will normally be bolted onto the vehicle's chassis. If the system is floating a wiring fault that causes a short to chassis will cause no damage, whereas if battery negative is earthed then a short to earth in motor or wiring would destroy the controller. Such faults are not likely and the user should make their own decision on earthing.

Slots are provided at the ends of the controller's base for mounting. These will accept an M5 or M6 screw.

Under no circumstances should any other mounting holes be drilled in the base as this could destroy the controller. When mounting the controller take great care that the heads of the mounting bolts cannot short to any of the controller's internal busbars.

5 Specifications

Supply voltage ‡ 1	15v to 45v 15v to 56v	36v version 48v version
Supply current	70mA	at zero speed
Output voltage (36v version)	36v to +36v 0 to 36v	J/S mode S/E mode
Output current, max	330A	typical
Current adjustment	330A to 70A	typical
Reverse current, max	270A	(cold)
Overheat cut out	95°C	(cold)
Ramp time	.3 to 12 secs	internal temperature
Switching frequency	20 kHz approximately	accel & decel rates independently adjustable
Overvoltage engage	47v 68v	24/36v versions 48v versions
Undervoltage	14 - 40v approx	adjustable
Size	280 mm x 103 mm x 60 mm	
Weight	1685g (of which heatsink is 725g)	
Input	5kΩ to 20kΩ Joystick or pot. or 0-3V (Adjustable) for-full speed	
Pot fault detection	40kΩ typically	
Mode switch	Single ended or Joystick	
Brake output	1A	tripped ‡ 2

Deadband With Issue 15 control boards, the zero speed deadband can be altered. This is beyond the scope of this manual but is fully explained on our [www site](http://www.4qd.co.uk/ser/v/4qd_transfer.html).
http://www.4qd.co.uk/ser/v/4qd_transfer.html 4QD series: removing input dead band.
Do not touch the Deadband header unless you understand its purpose.

- ‡ 1 Minimum voltage subject to alteration of the undervoltage setting.
- ‡ 2 Brake output is 'trip' protected: wiring or solenoid faults will switch off the controller.

6 Features

explanations of the features will be found under the section shown below.

Accel8	8
Adjustments	8
Battery	10
Brake	12
Brake defeat	8
Current	8
Drad band	12
Decel	8
Fuse	17
Gain	8
Ignition	12
Input	11
Joystick mode	12
Motor	10
Prereg	4
RAT	8
Splash plate	15
Symm reverse	8
Undervoltage	9
Zero	8

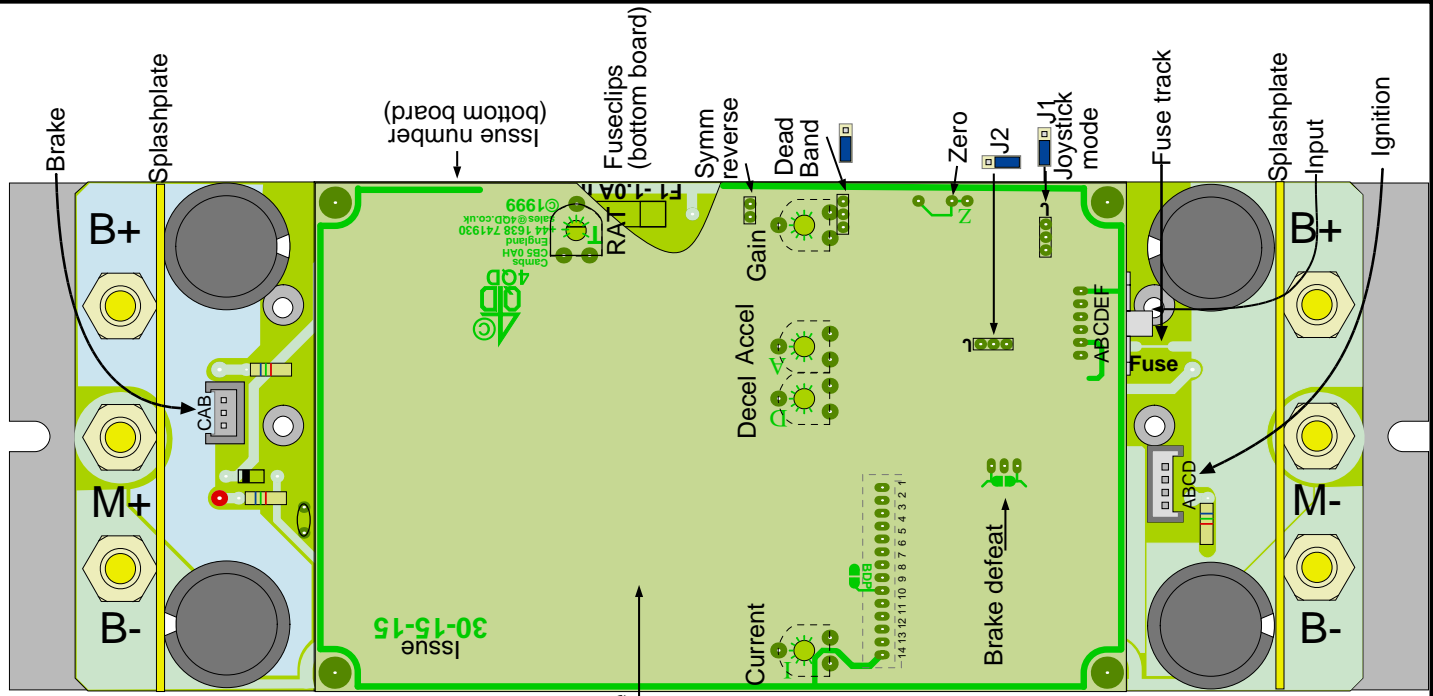

In Joystick mode, J2 must be set to the factory default. However if the *Dead-band* is set to *low in single-ended mode*, then the header J2 must be moved (or removed) or reversing will not properly operate. J2 disconnects Joystick direction control so must be

Reverse switch

uses the same connector as does the speed control (on the top board). Only use a reverse switch if the 4QD-200 is switched to single ended mode.

If you use a reverse switch in joystick mode you will not be able to go forward when the switch is closed - both joystick directions will be reverse.

If it simplifies the machine wiring, you may also reverse by applying battery +ve (rather than 12v) to the reverse input. Be careful however - a mistake in the wiring could put battery +ve onto pin 2 of the

Brake solenoid

Motors are available with an electromagnetic parking brake fitted. This brake is normally on. Power must be connected to the brake solenoid to release it.

Switching the solenoid is done by optional circuitry on the controller so that when the controller is switched off, or not running, the parking brake is on. This also gives a fail safe, in that if the controller dies for any reason, the electromagnetic brake will come on.

The brake connects between battery +ve and 'Brake' (pin B) on the 3 pin connector. The brake output is suitable for brake solenoids drawing up to 1A.

Inhibit input

Pin A of the 6 pin connector is an inhibit input.

One typical use of this would be in conjunction with a switch operated by the hand brake lever. When the brake is on the switch should short pin A to 0v (battery -ve) to inhibit the controller. Releasing the brake opens the switch and the controller automatically ramps up to the demand speed. This enables proper hill starting on the handbrake, whereas other inhibit signals (e.g. switching off the ignition) will cause the high-pedal lockout to engage.

The inhibit may also be used with a footbrake in which case it is possible to set the deceleration ramp to maximum time, when regen braking will have little

as supplied for Joystick mode.

It is possible to electrically centre the joystick by using the 'zero' point indicated on the 'features' diagram. However - mechanical centring is better and should generally be used in preference.

connector. This is the internal 12v line and applying battery +ve here is dangerous. Reverse is engaged if more than 5v is applied to the reverse line. Maximum allowable voltage is 60v on the reverse line.

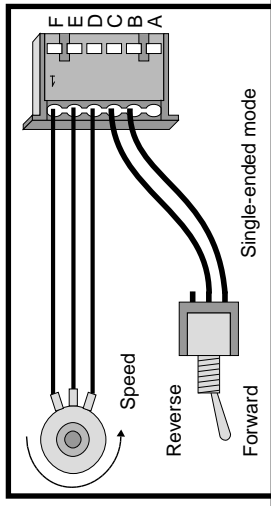

A spare battery - connection is present in case you wish to fit a manual override switch. The diagram shows how a 3 position override switch can be used to give release - brake - normal.

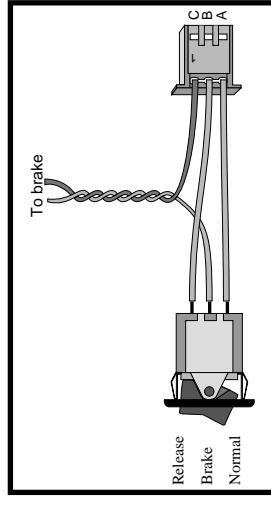

effect. The vehicle will now be stopped on the footbrake. Circuitry in the controller (issue 10 top boards and later) detects that the vehicle (motor speed) is reducing faster than the internal deceleration ramp and automatically ramps controller's internal demand speed down to match the mechanical braking.

This feature is not efficient - mechanical braking wastes energy - but when fitted to, for instance, a hire fleet of golf buggies, new drivers do not then experience unexpected braking when they release the throttle!

Ideally drivers should of course learn to use the regen braking rather than the footbrake!

Speed control pot

is essentially the same whether you use joystick or single ended mode. A 10K pot is suggested, but you can use any value from 1K to 22K. Higher pot values will cause the pot fault detection to operate.

Speed control wiring of both modes are shown in the diagram.

Top Speed adjustment

This is an optional addition. Either use a switch and a fixed resistor or use a pot in series with the wiper of the main speed pot.

A resistor (or a pot) of 62K will halve the top speed. A 200K pot would give a 3:1 top speed range. The diagram shows both the pot and the switch plus resistor but only one should be used.

Alternatively if it better suits the wiring, a resistor may be inserted in series with the top end of the pot. 10K with a 10K pot would halve the speed. Be careful not to exceed about 30K pot plus series resistor or the pot fault circuit may cut in.

High Pedal Lockout

The controller is fitted with a protection mechanism which disables it at switch on if the throttle pot is not at zero speed.

This safety feature is integral with the controller so

Battery meter

If a battery condition meter is required it can conveniently be connected to the 4 way connector.

Voltage Control

All of the inputs on the 4QD controllers are voltage controlled.

Speed is controlled by the voltage (0-3v minimum) on pin E of the 6 way connector. However when using a voltage you must fit a 10K resistor in place of the pot between pins D and F or the 'pot fault

Joystick (wig-wag) mode and Input deadband

Factory default positions of the headers are shown on the features diagram. Mode and deadband interact if low dead-band is engaged.

7 Controls

The feel, operation and safety of the vehicle will depend not only on the controller but very much on the controls you fit. This section discusses some of the points.

Throttle.

The first decision is whether to use a joystick or a straight speed throttle plus reverse switch. Joystick has to be hand operated but a straight throttle can be a hand or foot control. Mechanically also a straight throttle will usually be simpler. From the electrical point of view either is fine - the 4QD is electrically safe even against direction changes at full speed.

Acceleration.

Unlike a car you will have no gear change, so full speed is available almost from cold. The 4QD has a lot of power available for a cold start so that a sudden application of the throttle will cause a sudden surge of power. You can alter this by increasing the acceleration ramp on the board (at the expense of reducing the responsiveness). A similar adjustment controls the deceleration rate

Top Speed Adjust.

The facility is also available for an operator top speed control. Human nature dictates that this will be left at maximum so it may not be very useful. However it can give almost the same effect as a gear change: slow speed to start up, then switch to fast speed.

Electromechanical brake.

Electrical braking relies on the motor acting as a generator. Therefore when the vehicle is stopped (or at very low speeds) no electrical braking is possible and vehicle is free to roll. An electromechanical brake brakes the motor when no power is applied to it so that, when the controller is switched off, the motor cannot turn. The controller automatically applies power to the brake (to disengage it) as acceleration is applied and removes power a fraction of a second after the motor stops rotating.

Mechanical brake.

The electromechanical brake on the motor will only come on when the motor is rotating very slowly.

Therefore, on steep hills the regenerative braking works but the electromechanical braking won't come on. This is normally what is required but it means that stopping when going downhill is not possible, unless a mechanical braking system is fitted. In theory an emergency brake could be incorporated by switching off the power to the motor brake, except that this will place a heavy strain on the gearbox which could damage it, so this is not desirable.

A mechanical brake also gives the rider confidence, so that safety can be assured even if the controller fails. Better to have a brake and not need it than to need it and not have it!

More reading

4QD have a publication available which is compiled to answer all the technical questions we get asked. Called 'Battery Motors and Controllers' it is available for a small charge (order code PUB-BMC) and it will answer questions you didn't even know you needed to ask.

This information is also available via the Internet from 4QD's www site.

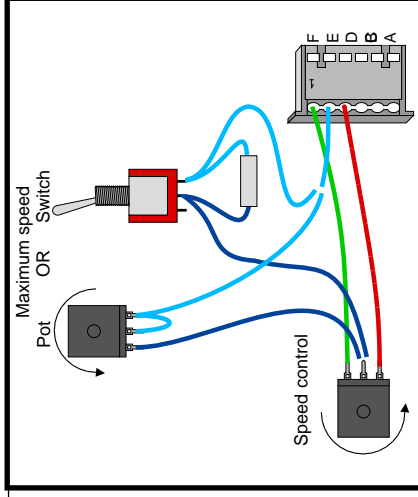
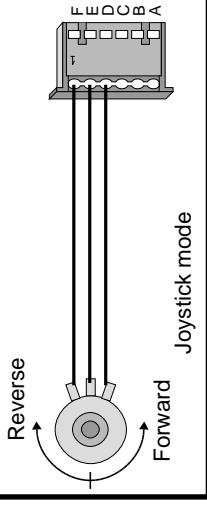

no provision is made to disable it completely. However the 'Inhibit input' forces the internal 'Demand Speed' (which is sensed by the HPLO function) to go to zero, disengaging the HPLO so the controller will always start when the Inhibit is removed.

Meter + is internally connected to the 'ignition' line - which is the battery positive, switched by the ignition switch so the meter is off when the ignition is off. Meter - is internally connected to battery -.

detector' circuit will engage. This will disable the pot fault feature.

This enables two controllers to be fed of the same pot: the common speed pot is connected normally to one controller and pins E on both controllers are joined. Ignition pins can be joined as can reverse pins.

As supplied, the controller is set up for 'single-ended' mode (speed and separate reverse switch) and high dead-band.

Mode is changed by moving the 'header' J1.

8 Adjustments

The controller will normally be supplied with these adjustments set to suit a typical application - so you may not have to alter anything.

There are five possible adjustments, two of which (marked ¶) you should **not** touch unless you are quite technical.

Refer to the 'Features' diagram to locate the adjustments.

Gain

This also acts as a pre-set top speed adjust.

The purpose of the gain control is to match the controller to the speed pot arrangement, since a twist grip may use only 90° of the available electrical travel whilst a plunger pot will use all of it.

The 'Gain' control is marked on the features diagram and has a G against it on the circuit board.

To set the gain, first chock up the drive wheels so they are clear of the ground and free to rotate.

- § Switch the controller on and select forward direction.
- § Have an assistant hold the throttle at full speed.
- § Adjust the Gain preset pot.
 - ⊗ Turn it down (anticlockwise) until the wheel speed starts to decrease.
 - ⊗ Now slowly turn it up (clockwise) until the wheel speed is just at maximum and won't increase any more.

It is easiest to do this if the Accelerate adjustment is fully anticlockwise (minimum ramp).

If this gain adjustment is too low the vehicle will loose top speed - it is then being used as a 'top speed' adjustment but do not cut the top speed too much. If you need to do this it means your gear ratio is too high and this will cause excessive motor current.

If this gain adjustment is too high the controller will reach full speed before the throttle pot reaches maximum deflection so there will be a 'flat' spot at full throttle. Also, reverse speed will now be more than half maximum speed.

Ramps

These control how sharply the machine accelerates or decelerates when the throttle is actuated sharply.

Acceleration. The preset marked A on the diagram adjusts the acceleration rate. Too long an acceleration time (clockwise) and the vehicle will be slow to pick up speed. Too fast a rate and the vehicle may do a wheel spin or, if badly balanced, will do a wheelie or dislodge the driver. Factory setting is at about 10 o'clock

Deceleration rate is adjusted by the preset marked D on the diagram. Too slow a deceleration and the braking will be ineffective in an emergency but too sharp a deceleration may throw the rider off the front of the vehicle. Normally this is best set slightly below acceleration, so the standard factory setting is at about 9 o'clock.

It is usually easiest to adjust these empirically. Factory settings are about right for 6-8 mph vehicles with fairly fast response. Trim them by trial and error to adjust the vehicle's handling as you require. Fast vehicles need longer ramps than do slow vehicles.

The ramp times are variable over a very wide range to allow for fast vehicles. By arrangement 4QD can alter the adjustment range for various uses.

¶ Current

this should not need adjusting: this is set at maximum when the controller leaves the factory and there is little point in altering it - unless you think the motors will be damaged by the available stall current.

¶ Reverse Acceptance Threshold.

Adjusting this requires a little technical understanding. It is marked RAT on the diagram (page 4).

Factory default: the threshold is set to maximum which suits most machines. The adjustment controls the threshold at which the controller will reverse. Normally the controller should reverse the motor before it is completely stopped.

We suggest you do not adjust this. It may need slight reduction for higher battery voltages and/or for low rolling friction vehicles.

The diagram shows the 6 way connector: open, closed and dismantled, to show the two stage latches which hold the cable grip in place. The cable grip is the top section. The numbers correspond with the 'Features' diagram.

If you need to open a closed connector, this is quite possible by gently lifting the ears of the cable grip outwards to release them from the latch but take care not to break them.

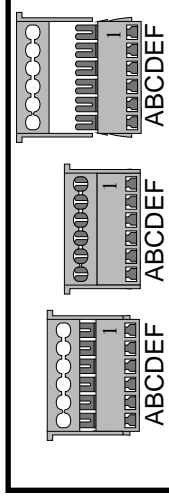

With the connector open, push the wires into the holes in the cable grip from the front which is as illustrated. The back has circular holes, not a slot.

When all the wires are in place, squeeze the connector closed in a vice, or with a pair of parallel jawed pliers.

Connections for each connector are shown, then follow more detailed information on the controls.

3 way connector

This is for the electromagnetic parking brake which connects between battery +ve and the centre pin. A third pin (0v or battery -) is supplied in case a brake override switch is required.

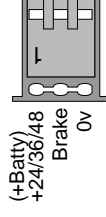

6 way connector

Note that this connector is underneath the top board so refer to the 'features' diagram to identify the pin letters. You will have to release the top board (four 'Board Release' screws on the features diagram) to insert access the 6 way connector.

This connects the speed pot and the direction switch. Direction change is by applying a voltage to pin C: no voltage (pin disconnected) will give forward.

To reverse, connect this pin to a voltage, e.g. pin B or battery +ve.

There is also an inhibit pin: connecting this to 0v will inhibit the action of the speed pot

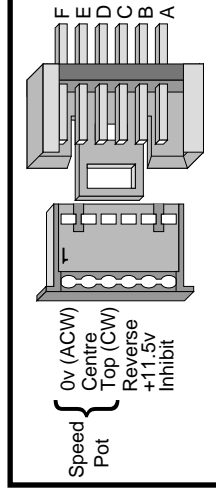

4 way connector

This is principally for the 'ignition' switch but two spare pins are supplied, one connected to the 'ignition line and the second to 0v (battery -)

for a battery condition meter or a reverse polarity protection relay.

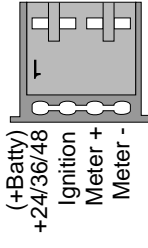

12 Wiring - various

Ignition light

The diagram shows how an LED may be fitted to act as an Ignition light. This can be a useful diagnostic aid if the controller shuts down because of overheating, dud wiring or some other fault. However such problems are relatively rare so the LED is more cosmetic.

Note that pin 2 is also +12v to the direction switch and that pin 6 also connects to the speed pot.

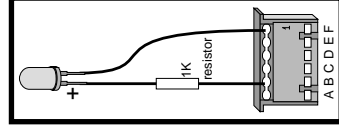

Ignition switch

Connects between +Batty and 'Ignition' on the 4 pin connector. When the switch is open the control circuitry is disabled, turning off the 4QD-200. When closed the 4QD-200 is turned on. The current through the switch is very small so a low current switch may be used.

The controller will not work at all without this connection.

The ignition is operated by a voltage so it can be operated by applying a voltage from a source other than the +Batty pin.

10 Power Connections

Battery & motor wire size

This should be heavy gauge. For full output you will probably use two motors. Battery drain is typically about half the motor current (this depends on the speed) so 10.0 mm² wire (which will carry about 70 amps continuously) will probably be adequate for the 4QD-300. Double strands of 6mm² would be better.

The drawing shows the base board with the control (top) board removed. The adjustment is to the left of the 14 way connector.

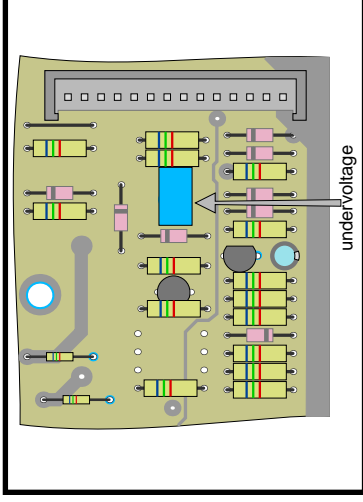

Typical voltages for various settings are shown below. Note that these figures are not guaranteed: if you need accurate setting, measure it!

Position	U/V	For Battery
Fully clockwise	40v	
3 o'clock	37v	48v
centre	27v	36v
9 o'clock	17v	24v
Fully anticlockwise	14v	

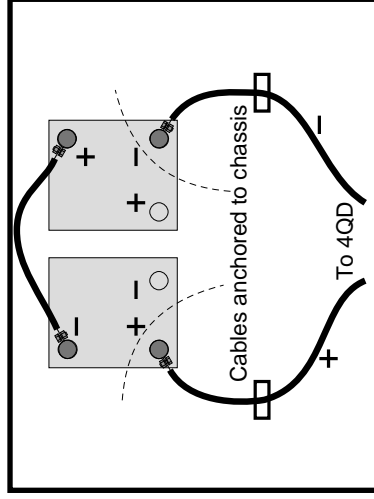

Battery leads are clamped to the vehicle's chassis in such a way that the positive lead can only reach the positive terminal, and then only if the battery is fitted the correct way round in the vehicle.

With incorrect battery fitting the -ve terminal (on the left) cannot be reached by the positive cable

Be warned that, when you connect the battery, there will be a rather large spark as the capacitors in the

Keep the battery and motor wires as short as possible. Excessive battery wiring length will cause reduced voltage to the controller at full output, giving reduced output current and degrading performance. Long battery leads can also cause the 4QD's capacitors to work harder when they may heat up, reducing their life.

WARNING be very careful with the battery wiring. The 4QD is not polarity protected and any mistake with battery wiring will destroy the controller. The battery should be the last item you connect, and you should disconnect the battery before changing any other wiring. Reverse polarity protection can be added simply by fitting a relay in the wiring if required - see facing page - and this is **strongly recommended**.

To avoid mistakes, chose a battery layout such that the terminals cannot be wrongly connected. One such layout is shown in the diagram

controller charge. This does not indicate a fault and is quite normal. The capacitors are a very necessary item (their purpose is to hold electricity to supply current during the very fast switching of the controller). The capacitors can hold their charge for quite a time, so if you disconnect the battery then re-connect it (even several minutes later) the spark may not occur the second time. Fitting a reverse polarity protection relay cures this spark.

Also: use good quality battery connectors. The 4QD regenerates energy back into the battery during braking. If the battery connection falls off at this time then the regenerated energy cannot be dumped and it will cause the voltage on the controller to rise to a destructive level. Although this switches the controller off, all control over the motors will be lost

Undervoltage protection

Undervoltage protection has two functions:

- 1 It can protect the controller from the effects of a failed battery.
- 2 It can prevent damage to a battery which can be caused by excessively discharging it.

Failed battery

If one cell in a battery fails, the effects at high current can be unpredictable and can blow the controller - since the battery voltage can disappear very fast indeed!

Therefore adjustable battery undervoltage is now fitted. It is adjustable (by means of a preset adjustment on the base board) between about 14v and 40v.

Battery Contactor

A contactor should be fitted in the battery line as shown. This provides an emergency power disconnect so is a vital, safety feature. It also gives protection against reversing the batteries.

The relay coil is fed from the ignition switch connector. A 470ohm, 2 watt resistor must be fitted across the relay contact to pre-charge the main capacitor in the controller.

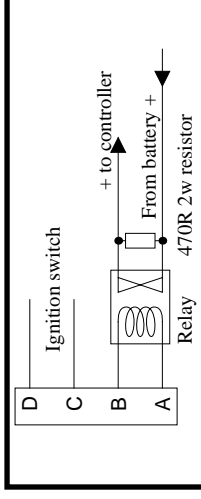

When the battery is connected up, current flows through the resistor to charge up the controller's capacitors. When the ignition is switched on, the capacitors are connected across the relay coil which pulls in, shorting out the resistor. If the battery is reversed the MOSFETs in the controller short out the capacitors so they do not charge up and the relay cannot operate. The fault current is limited by the resistor to a safe value.

⚡ Circuit breaker or fuse.

Use of a circuit breaker or fuse is optional: in practise circuit breakers and fuses aren't fast enough to protect semiconductors, so may not offer the controller full protection.

However a circuit breaker can also act as a power switch to disconnect the battery. It is also possible that a suitably small fuse or breaker in the battery could protect against reversed battery, but this will depend on the size of the battery wiring and the response of the breaker.

If fitting a breaker in the battery this should never be opened while the motor is running: as the controller brakes it feeds energy back into the battery. If this is disconnected, the controller can generate a very high voltage as it tries, in vain, to regenerate the braking energy.